







13 801 845



- 210mm projection
- circular normal flow
- hole diameter 37 mm
- 1/2" connection
- plug-link mounting
- max. flow 21.5 l/min at 3 bar flow pressure
- WRAS 2207003

	Brushed Platinum	13 801 845-06
	Chrome	13 801 845-00
	Dark Chrome	13 801 845-19
	Matte Black	13 801 845-33
	Brushed Chrome	13 801 845-93
	Brushed Dark Platinum	13 801 845-99

Required miscellaneous

Concealed adapter -

35 080 970-90
0010



13 801 845

mm [inches]

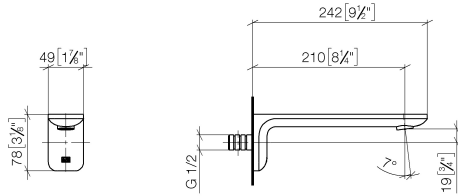

Flow rate chart

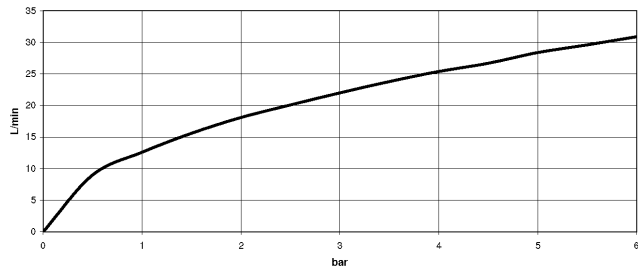

Codes & Standards

ASME
A112.18.1/CSA
B125.1



LISSÉ Bath spout for wall mounting - Brushed Platinum

LISSÉ

13 801 845

Certificates

IAPMO_4976 (6). LGA_29012. WRAS_2207003.

13 801 845

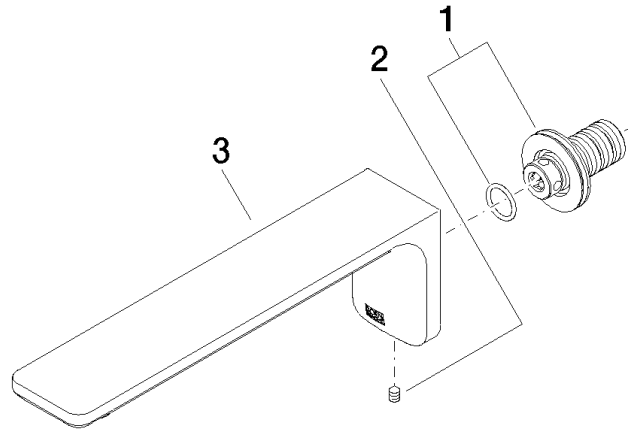

Spare parts list

No.	Item Number	Name	Quantity used	Delivery time
1	90 24 03 108 00 90	nipple set	1	2
2	90 31 11 004 00 90	pin	1	2
3	90 11 84 014 02-06	spout	1	10